

# NJ tree generated by a cgMLST analysis

(1131 loci)

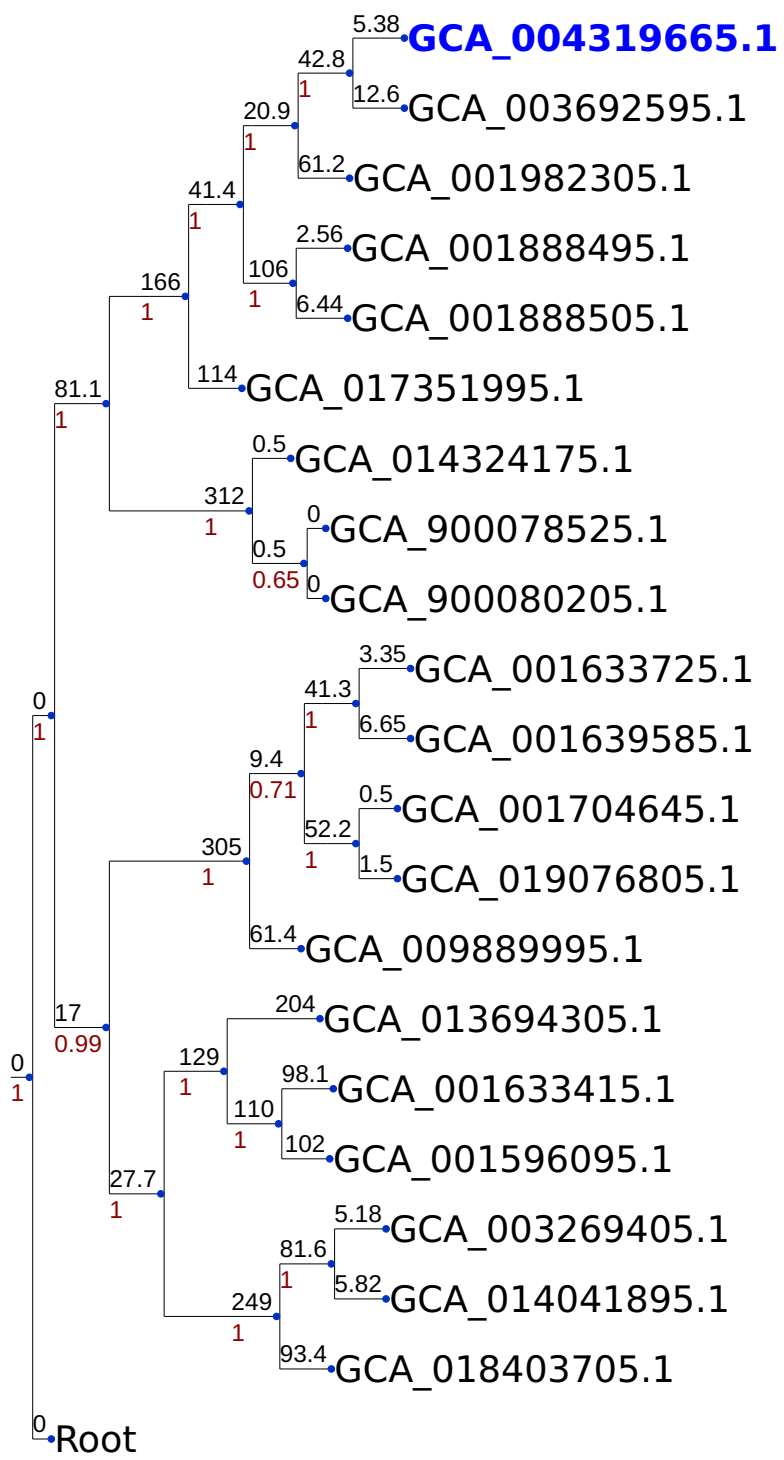

250