

NJ tree generated by a cgMLST analysis

(756 loci)

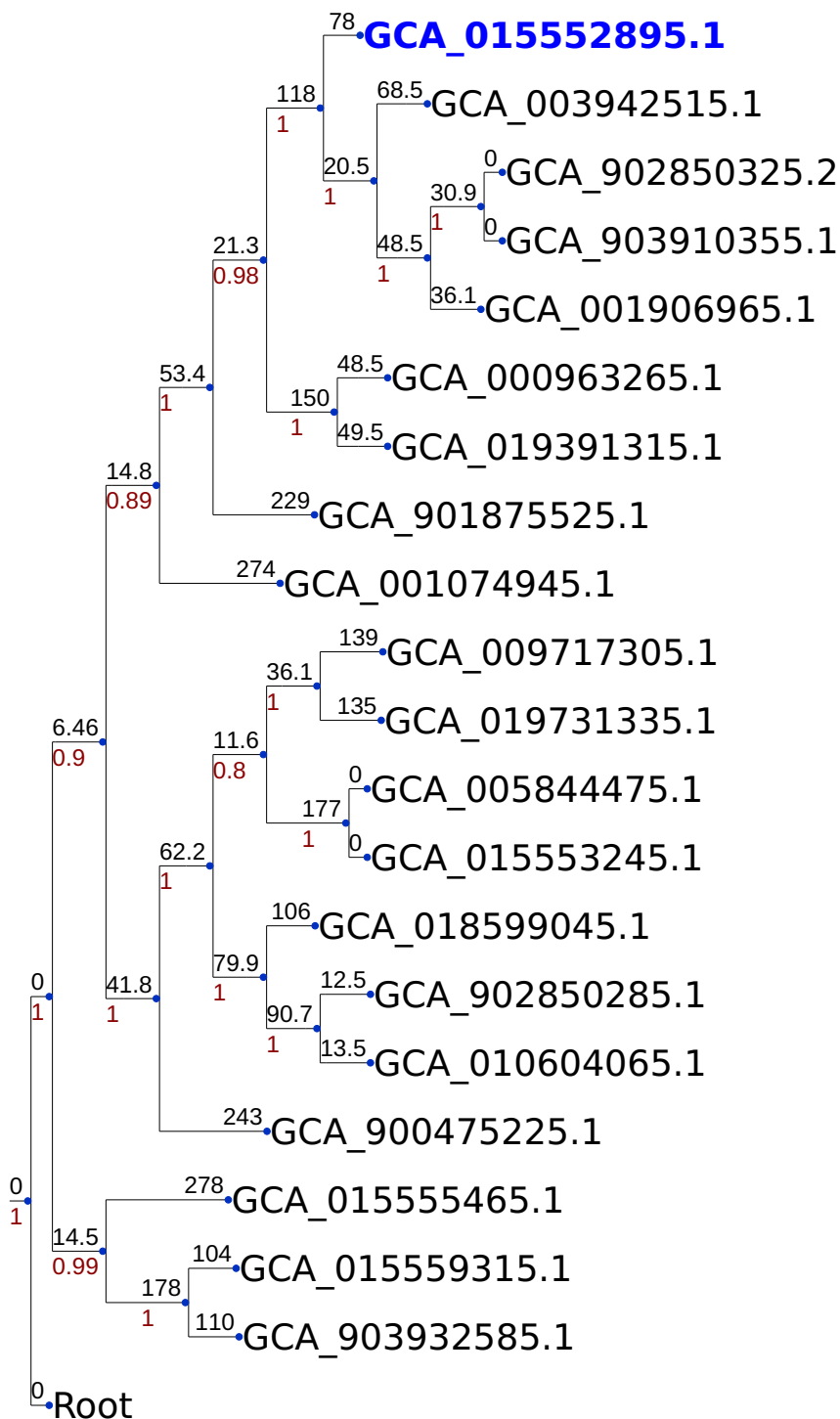

250