

# NJ tree generated by a cgMLST analysis

(895 loci)

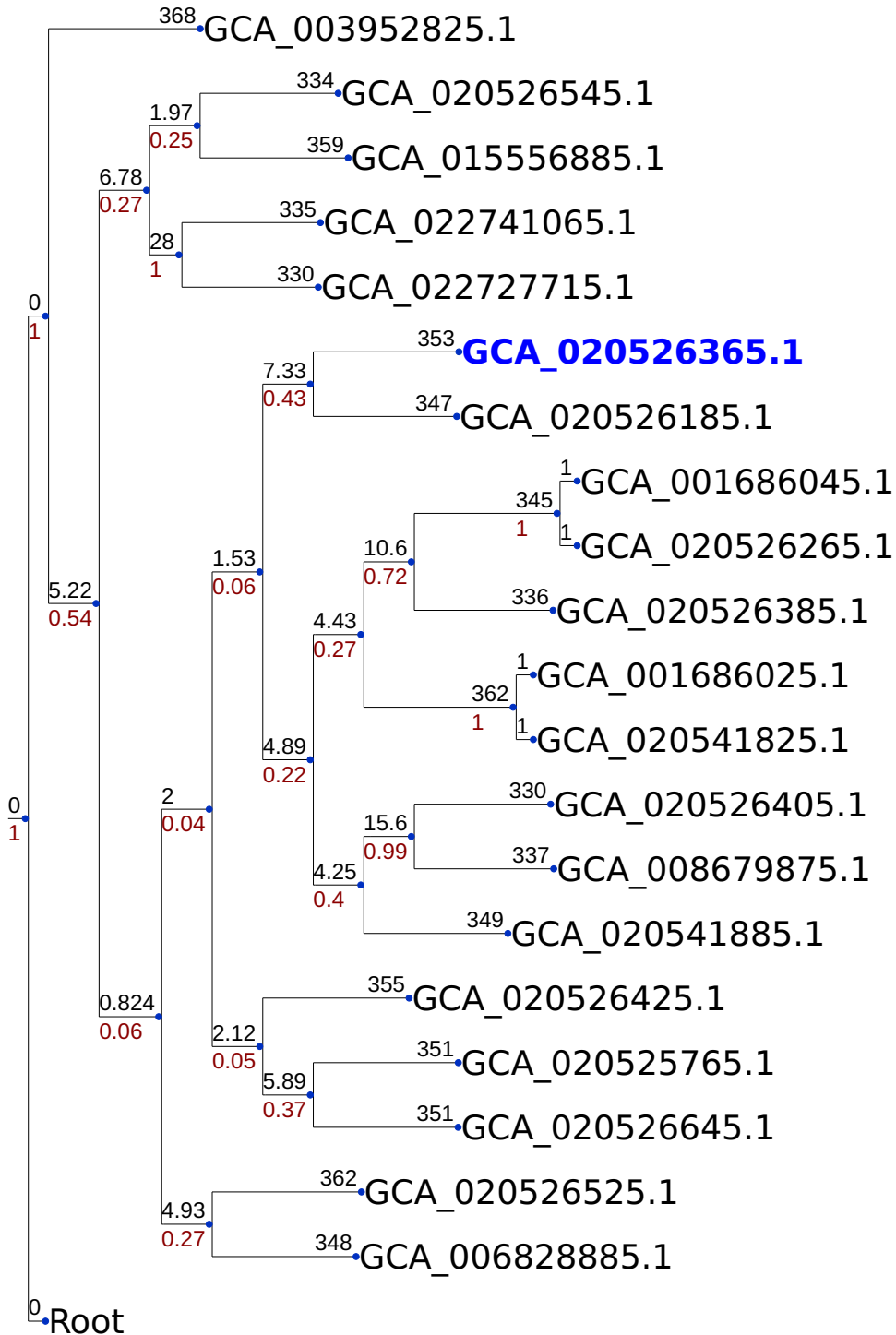

250