

NJ tree generated by a cgMLST analysis

(817 loci)

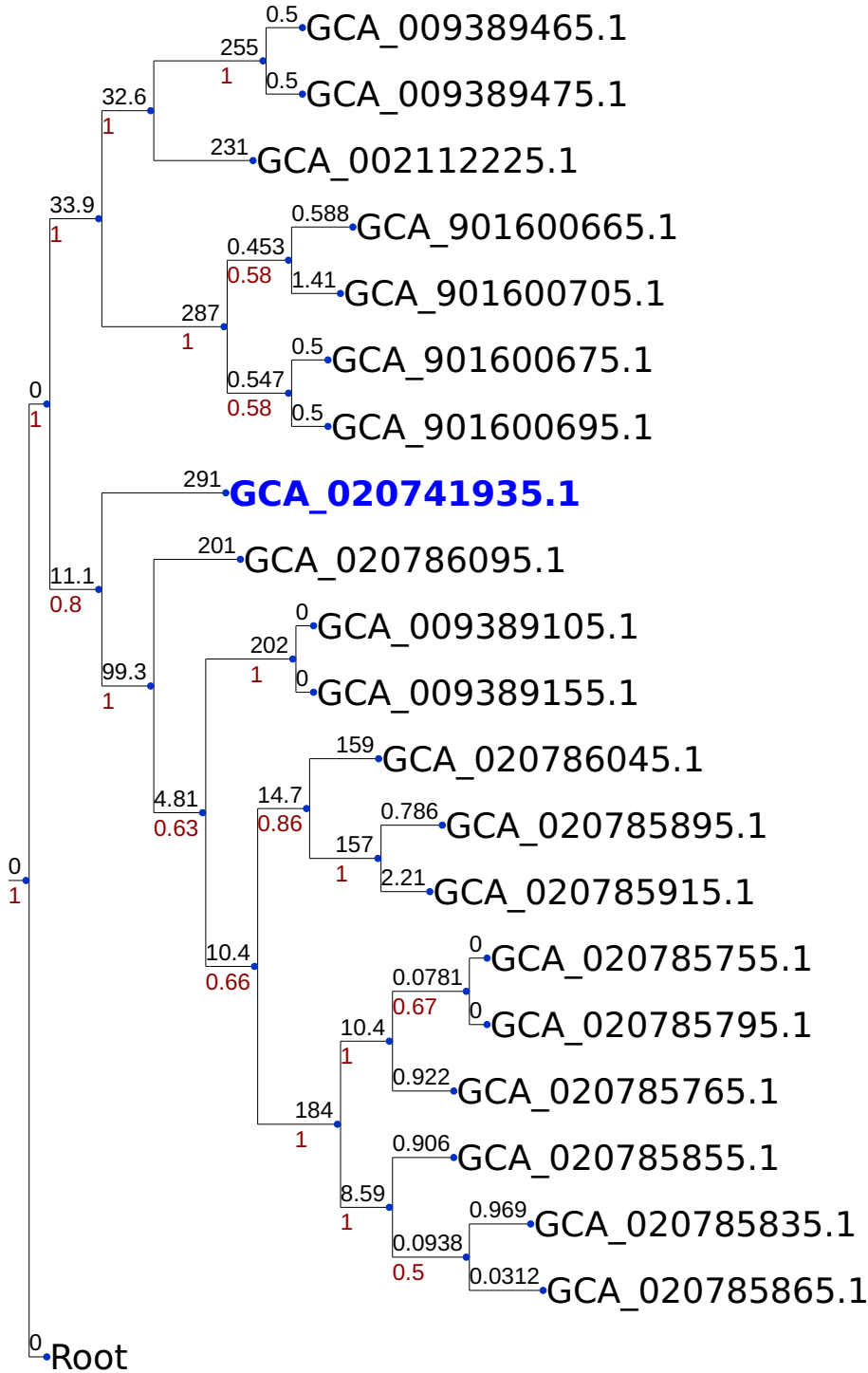

250