

# NJ tree generated by a cgMLST analysis

(1888 loci)

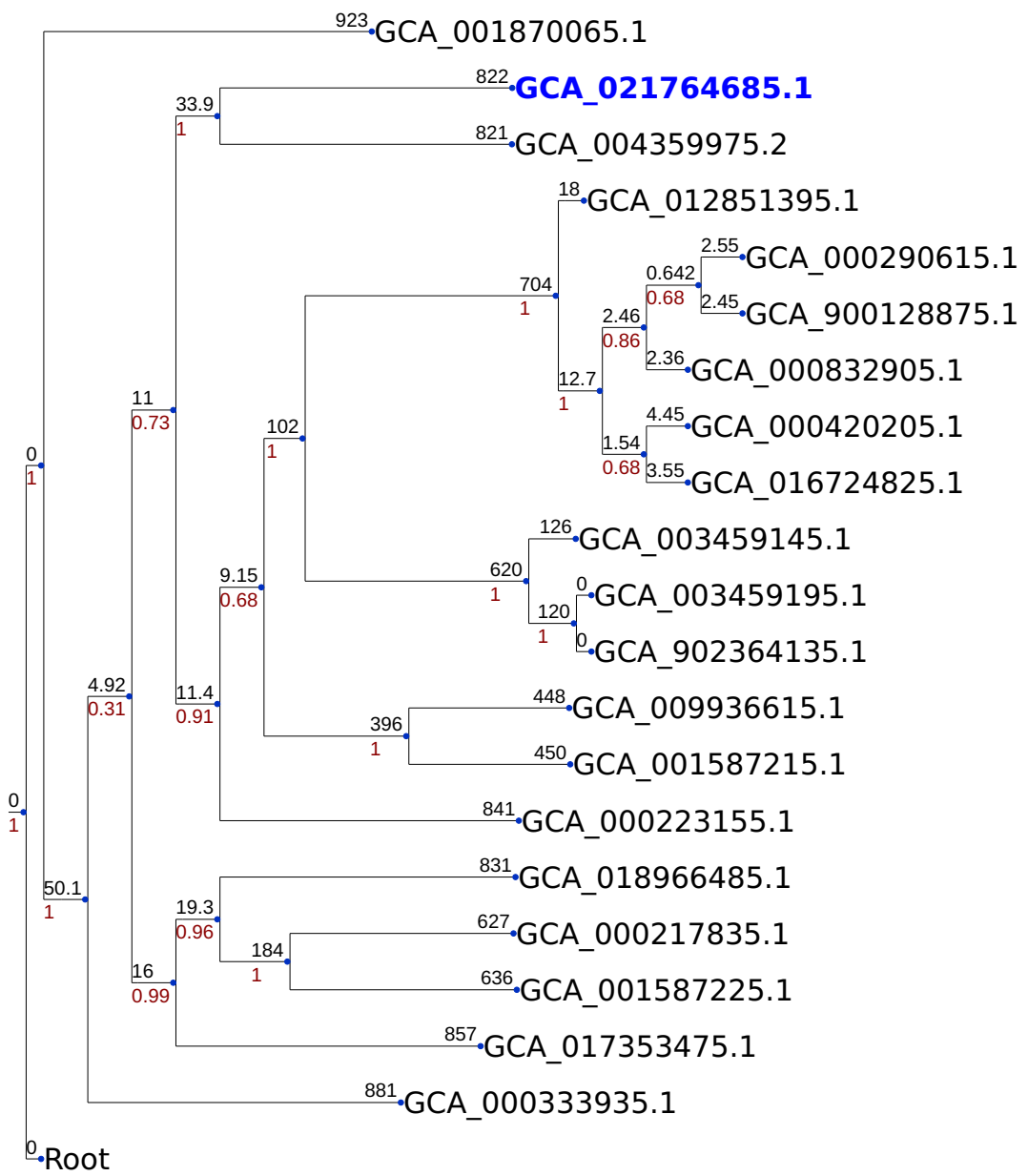

250